

1

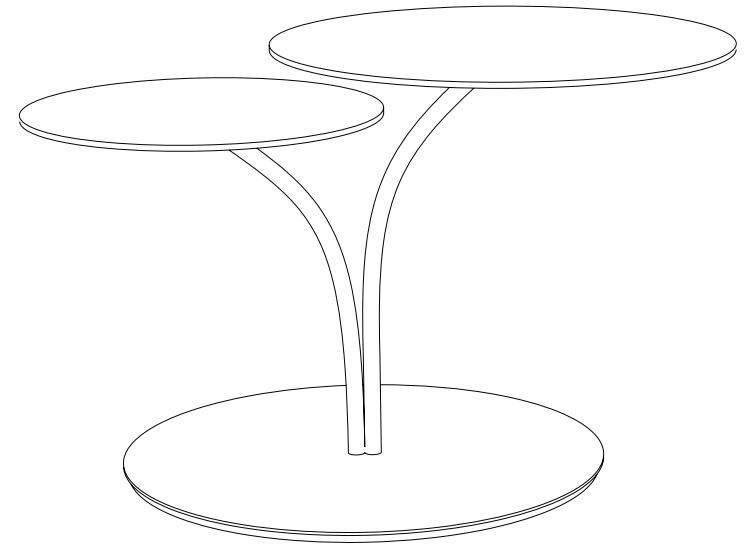

H&M HOME

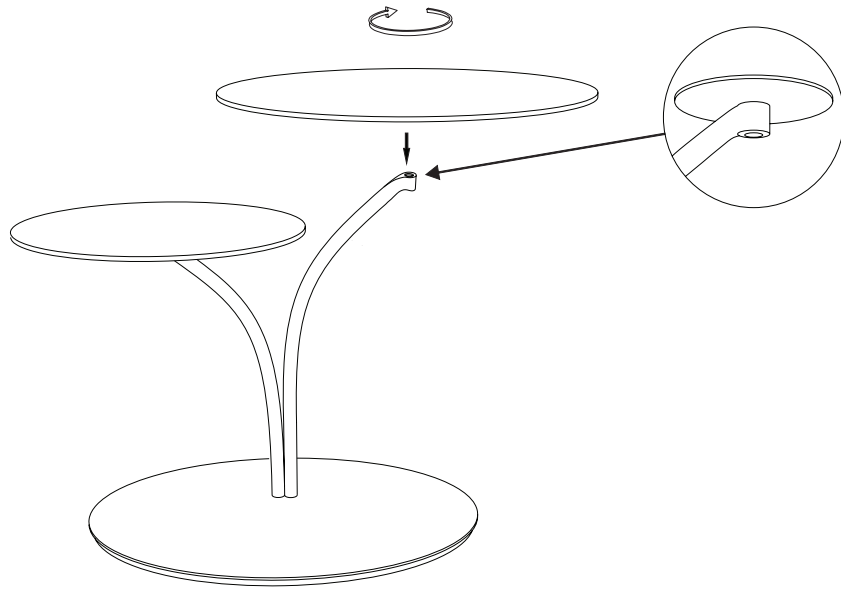
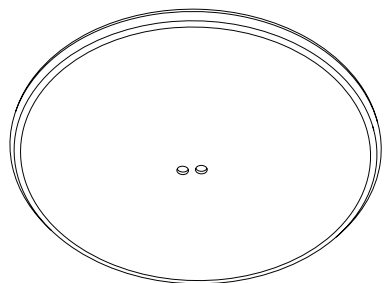

x1

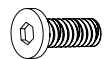

x2

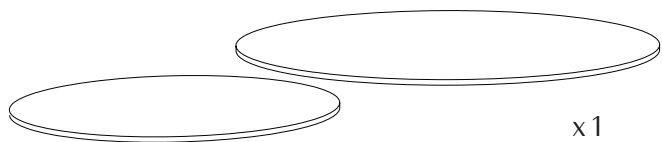

x1

x1

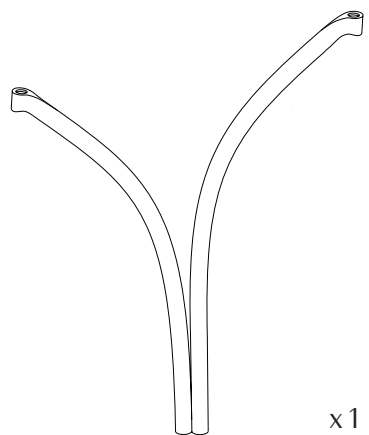

x1

---

1

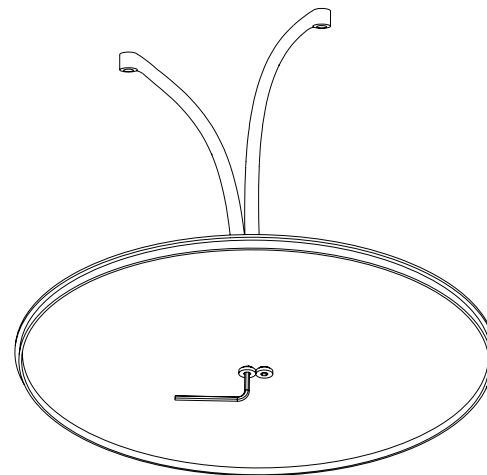

---

2

